

TUNEL OGRODOWY "POMIDOR ECO" 210X156 INSTRUKCJA MONTAŻU

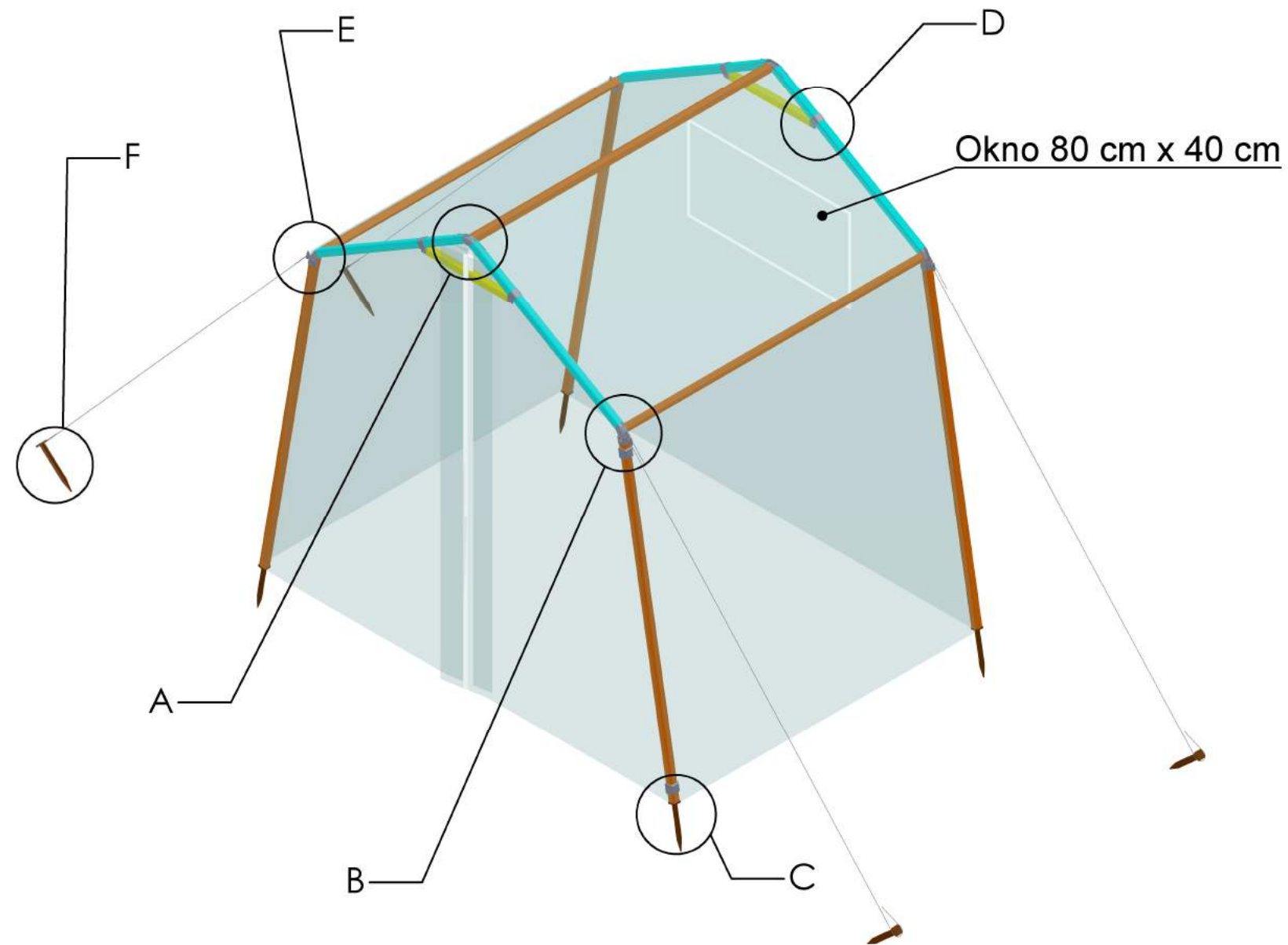

LP	SPIS CZĘŚCI	ILOŚĆ
1	F-1	1
2	L-1	4
3	P-03	4
4	P-10	7
5	P-13	2
6	R-1	1
7	SZ-2	4
8	SZ-3	4
9	W-1	ok. 100
10	Z-09	6
11	Z-11A	4
12	Z-13	4
13	Z-14	40

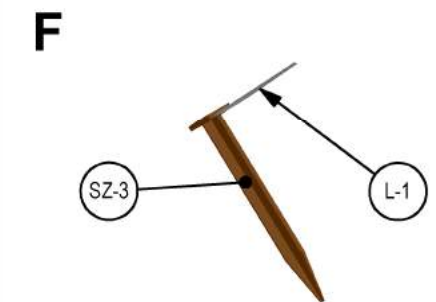

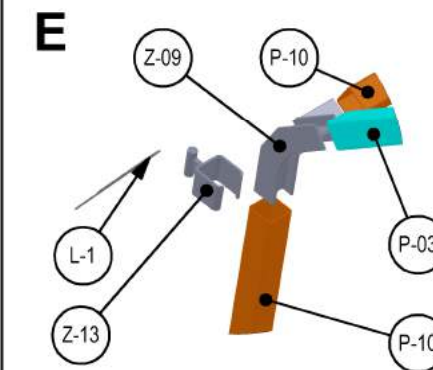
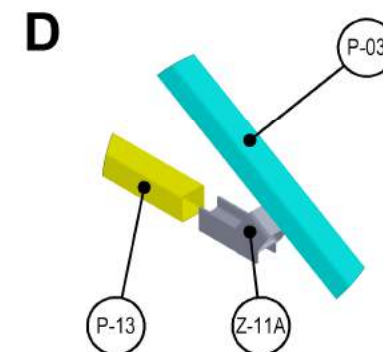
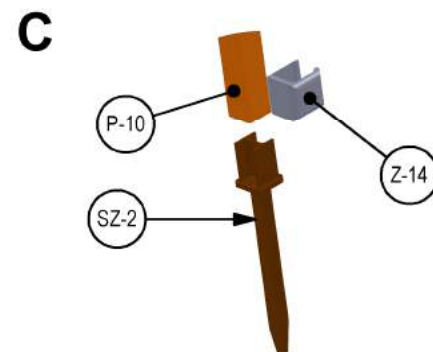
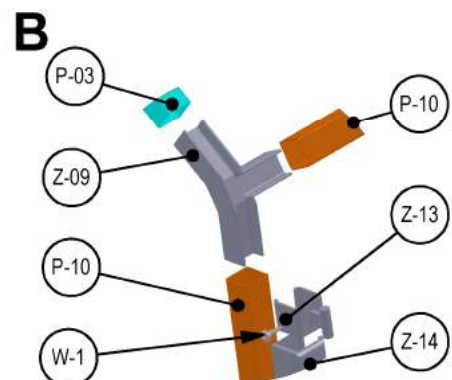
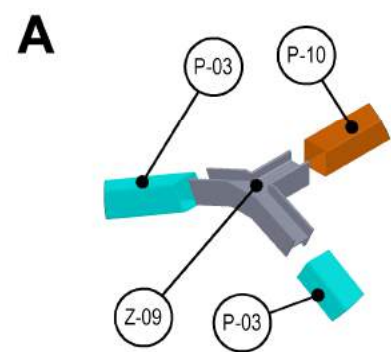
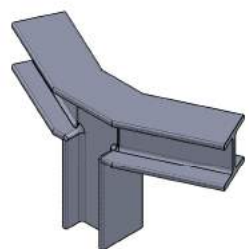

Z-09
Widok: A,B,E
Ilość: 6



Z-11A
Widok: D
Ilość: 4

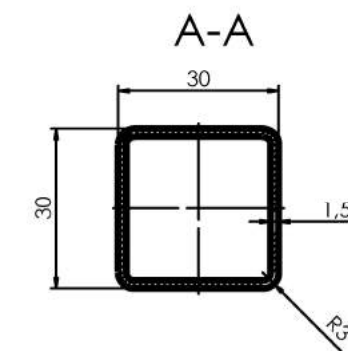
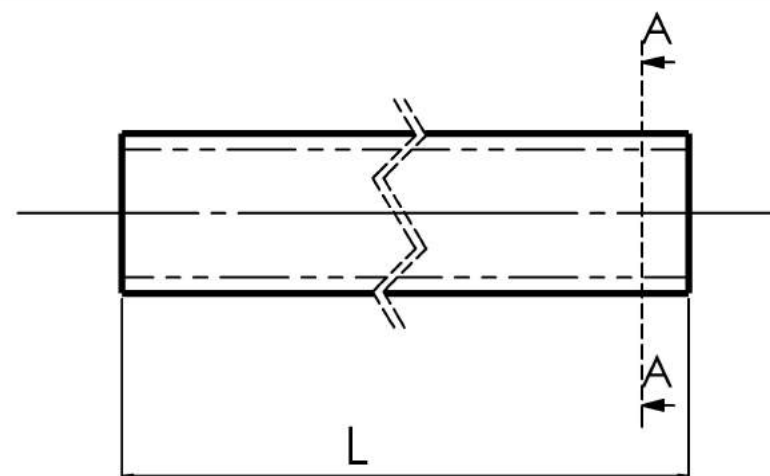

Z-13
Widok: B,E
Ilość: 4



Z-14
Widok: B,C
Ilość: 40



P-03
Długość: L=850 mm
Widok: A,B,D,E
Ilość: 4



P-13
Długość: L=410 mm
Widok: D
Ilość: 2



W-1
Widok: B
Ilość: ok. 100



SZ-2
Widok: C
Ilość: 4



P-10
Długość: L=1500 mm
Widok: A-C,E
Ilość: 7

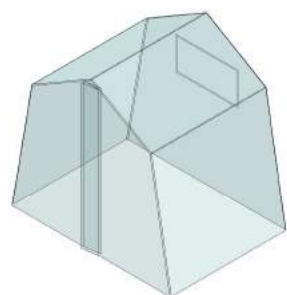

F-1
Widok: Ogólny
Ilość: 1



SZ-3
Widok: F
Ilość: 4



R-1
Długość: 3,5 m
Widok: Ogólny
Ilość: 1



L-1
Długość: 10 m
Widok: E,F
Ilość: 1